

Group I intron

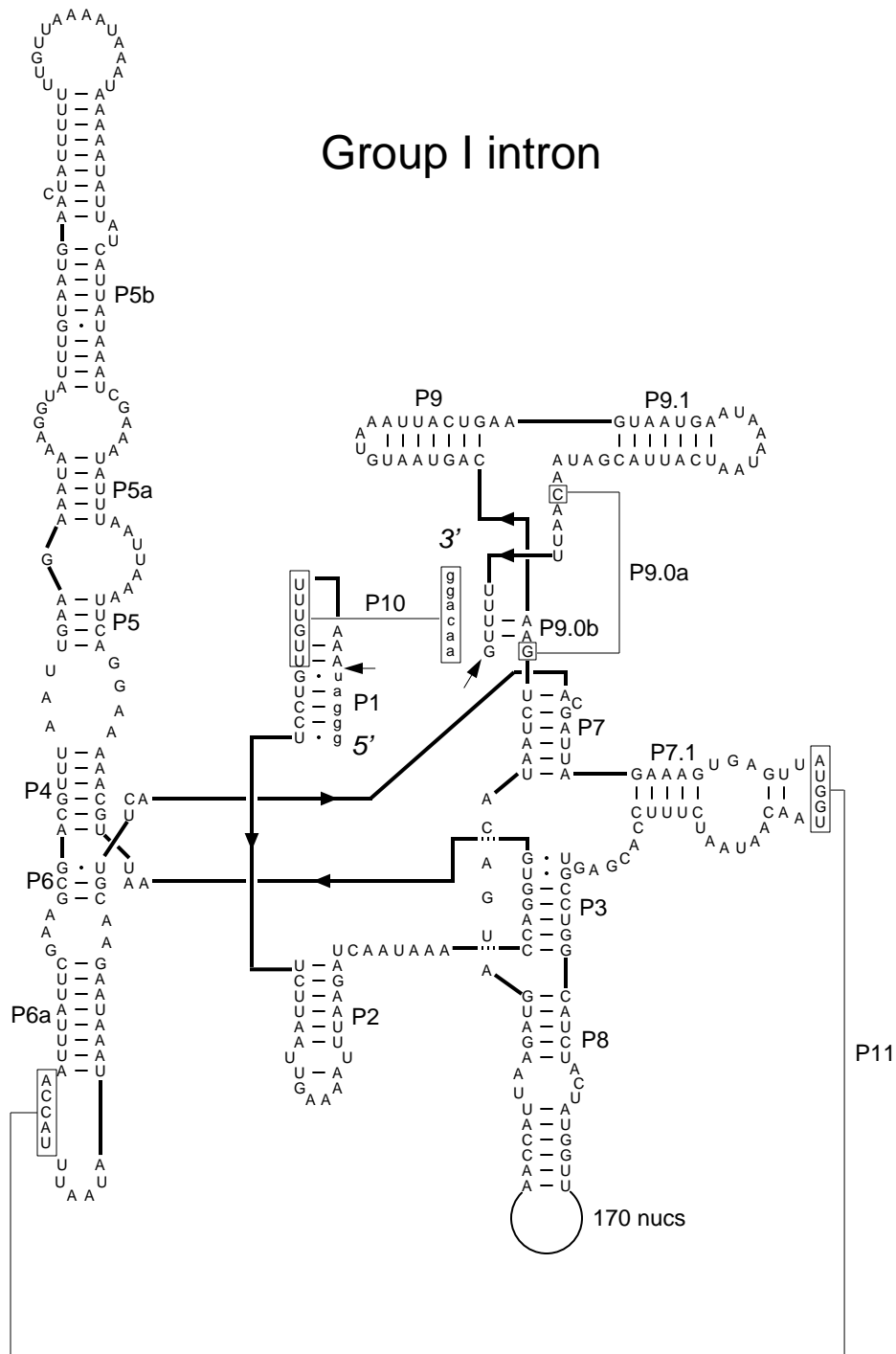

Suillus luteus [Mitochondrion] LSU [i6;2449]
(L47586)

Eucarya, Fungi, Basidiomycota (IA1)

Feb. 5, 1998

Citation and related information available at <http://www.rna.ccbb.utexas.edu>