

Secondary Structure: transfer RNA

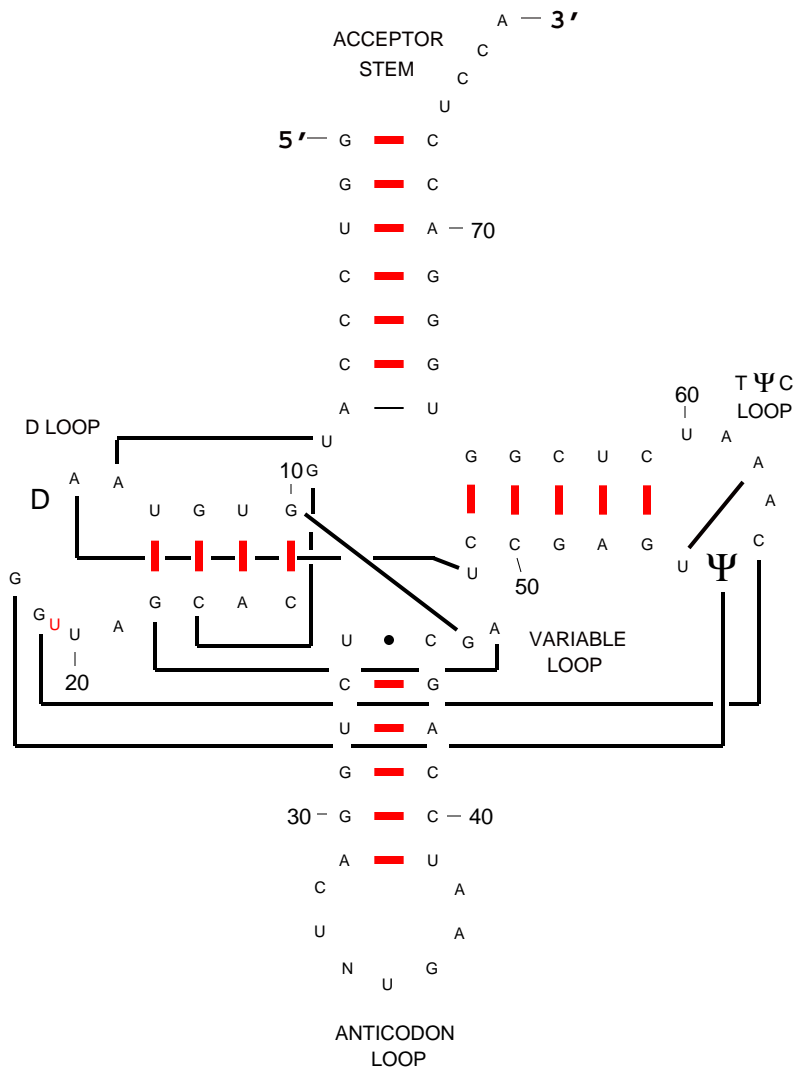

Homo sapiens

(X15813)

1.cellular organisms 2.Eukaryota 3.Fungi/Metazoa group
4.Metazoa 5.Eumetazoa 6.Bilateria 7.Coelomata
8.Deuterostomia 9.Chordata 10.Craniata 11.Vertebrata
12.Gnathostomata 13.Teleostomi 14.Euteleostomi
15.Sarcopterygii 16.Tetrapoda 17.Amniota 18.Mammalia
19.Theria 20.Eutheria 21.Primates 22.Catarrhini
23.Hominidae 24.Homo

Jun, 2002

Citation and related information available at <http://www.rna.icmb.utexas.edu>