

Secondary Structure: transfer RNA

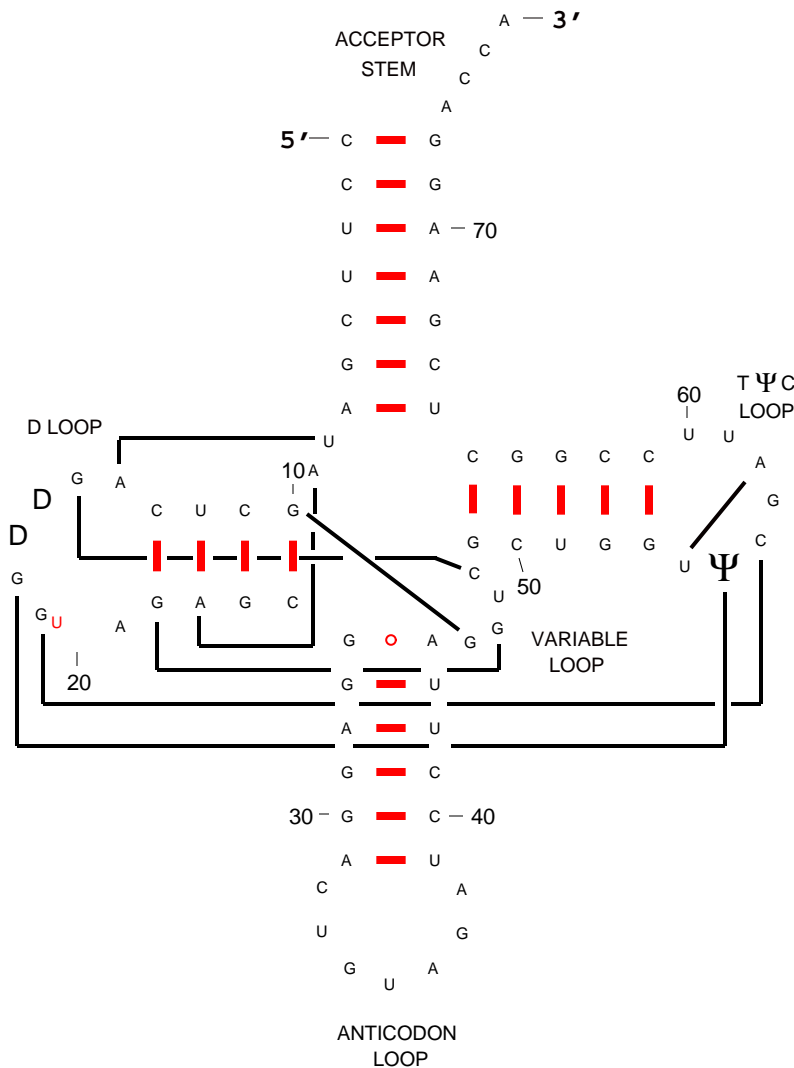

Homo sapiens

(X04779)

1. cellular organisms
2. Eukaryota
3. Fungi/Metazoa group
4. Metazoa
5. Eumetazoa
6. Bilateria
7. Coelomata
8. Deuterostomia
9. Chordata
10. Craniata
11. Vertebrata
12. Gnathostomata
13. Teleostomi
14. Euteleostomi
15. Sarcopterygii
16. Tetrapoda
17. Amniota
18. Mammalia
19. Theria
20. Eutheria
21. Primates
22. Catarrhini
23. Hominidae
24. Homo

Jun, 2002

Citation and related information available at <http://www.rna.icmb.utexas.edu>